

Specifications		WE00S1ET00	WE00C2HT00
Power supply			
230V 1~+N+T 50/60Hz ●			
Versions			
1 relay ●			
4 relay ●			
Controllers			
WE00S1EN00 ●			
WE00C2HN00 ●			
Inputs/Outputs			
NTC probes inputs 2			
Digital inputs 3			
Digital outputs 1			
Other Specifications			
Casing dimensions (mm) 128x290x101			
Casing material Plastic			
Protection rating IP54			
Packaging Single			
Weight KG tbd			
Terminal block support ●			
Operating conditions -10T45°C; humidity <90% r.H. non-condensing			
Storage conditions -20T70°C; humidity <90% r.H. non-condensing			
Class of protection against voltage surges Category II			

- standard
- optional
- not present

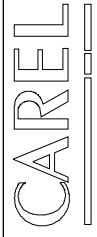

TECHNICAL SPECIFICATIONS

PROJECT	WE00C2HT00R0.DWG
CLIENT	
DRAFT M.B.	DATE 14/04/2016
SHEET	2 OF 6
FOLLOWS	3

REV.	MODIFY	DATE	NAME

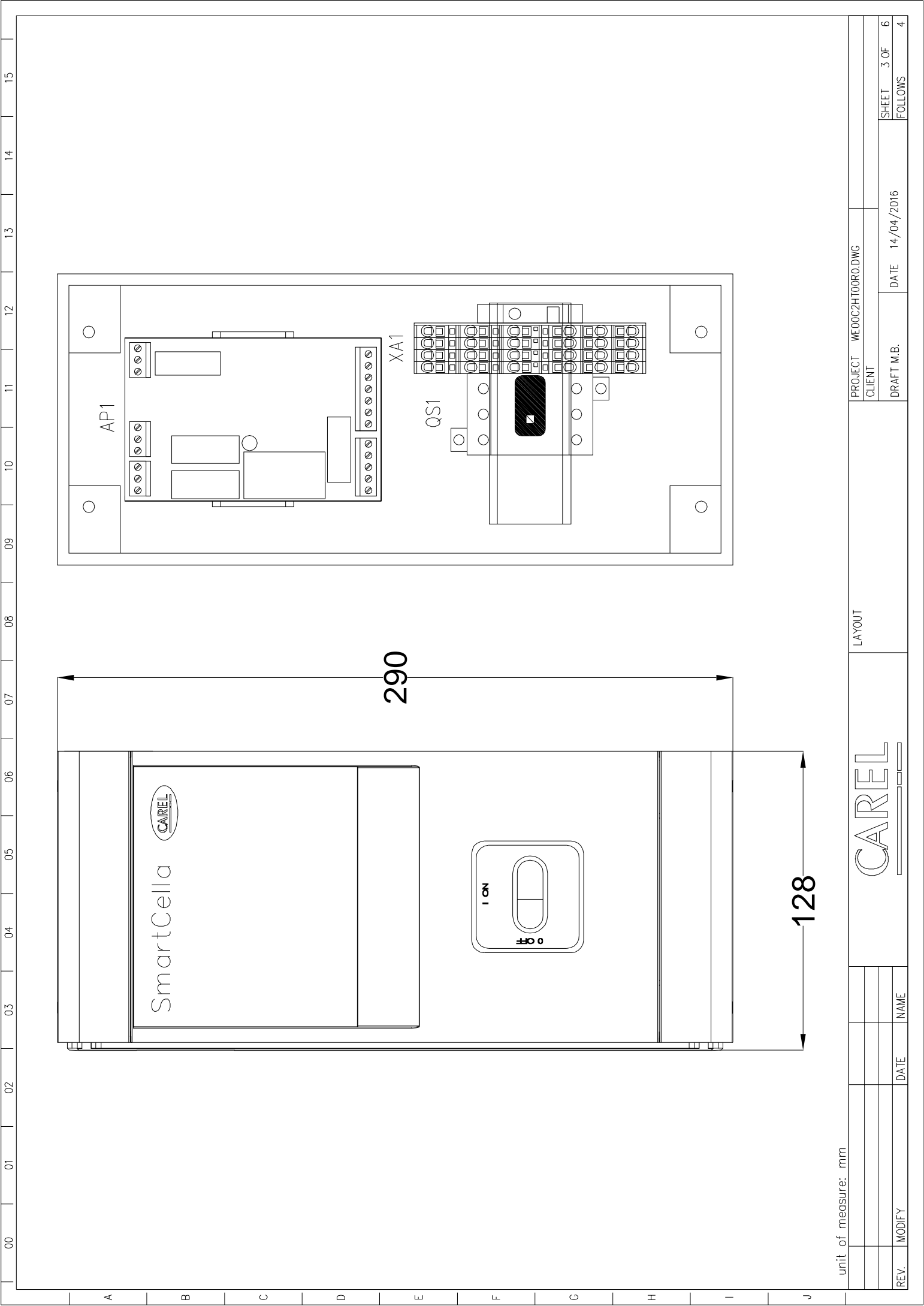

00 01 02 03 04 05 06 07 08 09 10 11 12 13 14 15

A B C D E F G H I J

unit of measure: mm

REV.	MODIFY	DATE	NAME	<h1>CAREL</h1>	LAYOUT	PROJECT WE00C2HT00R0.DWG
					CLIENT	DATE 14/04/2016
					DRAFT M.B.	SHEET 3 OF 6
						FOLLOWS 4

00 01 02 03 04 05 06 07 08 09 10 11 12 13 14 15

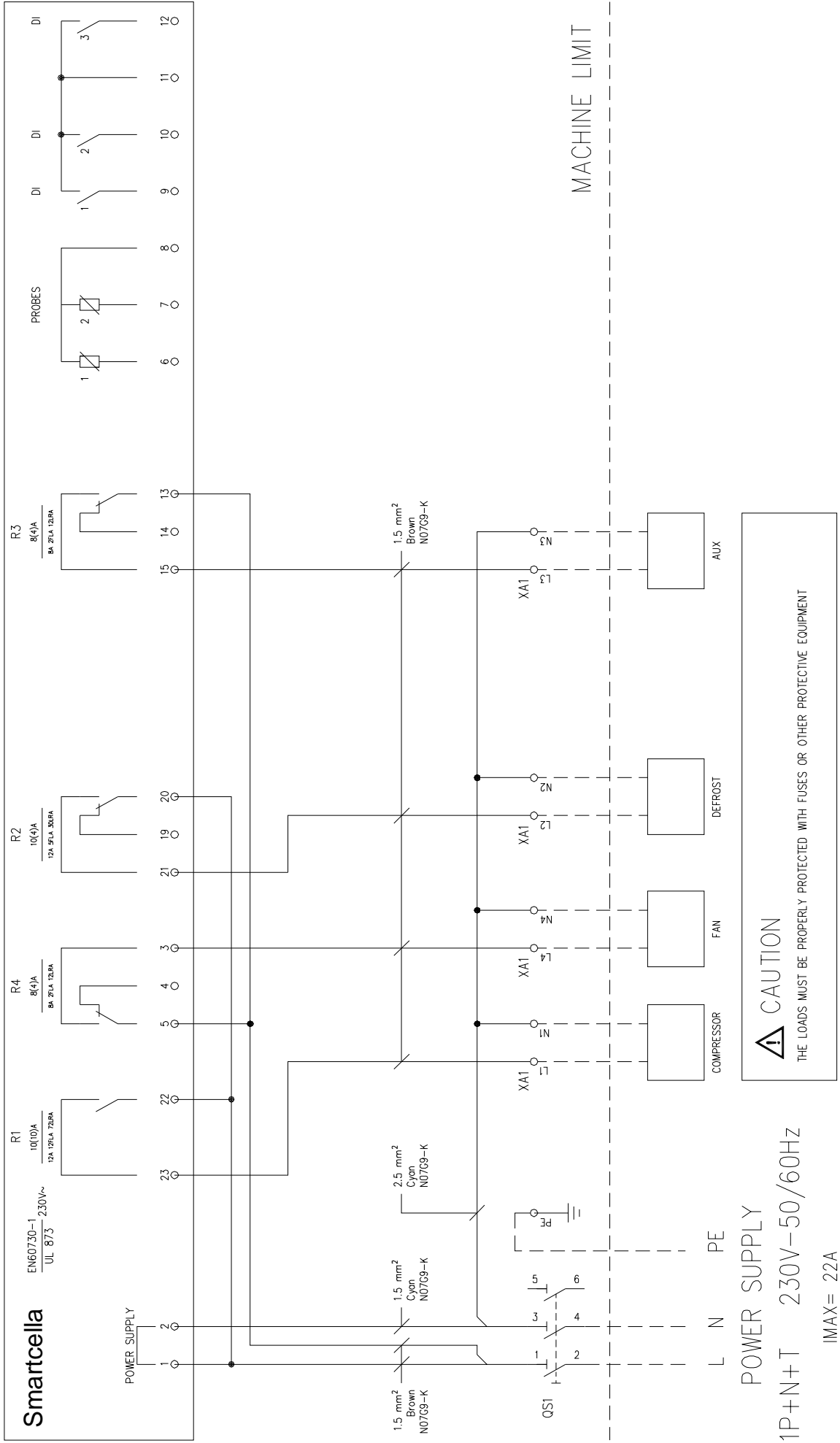

REV.	MODIFY	DATE	NAME	ELECTRIC CIRCUIT		PROJECT	WE00C2HT00R0.DWG
				CAREL		CLIENT	
						DRAFT M.B.	DATE 14/04/2016
						SHEET	4 OF 6
						FOLLOWS	5

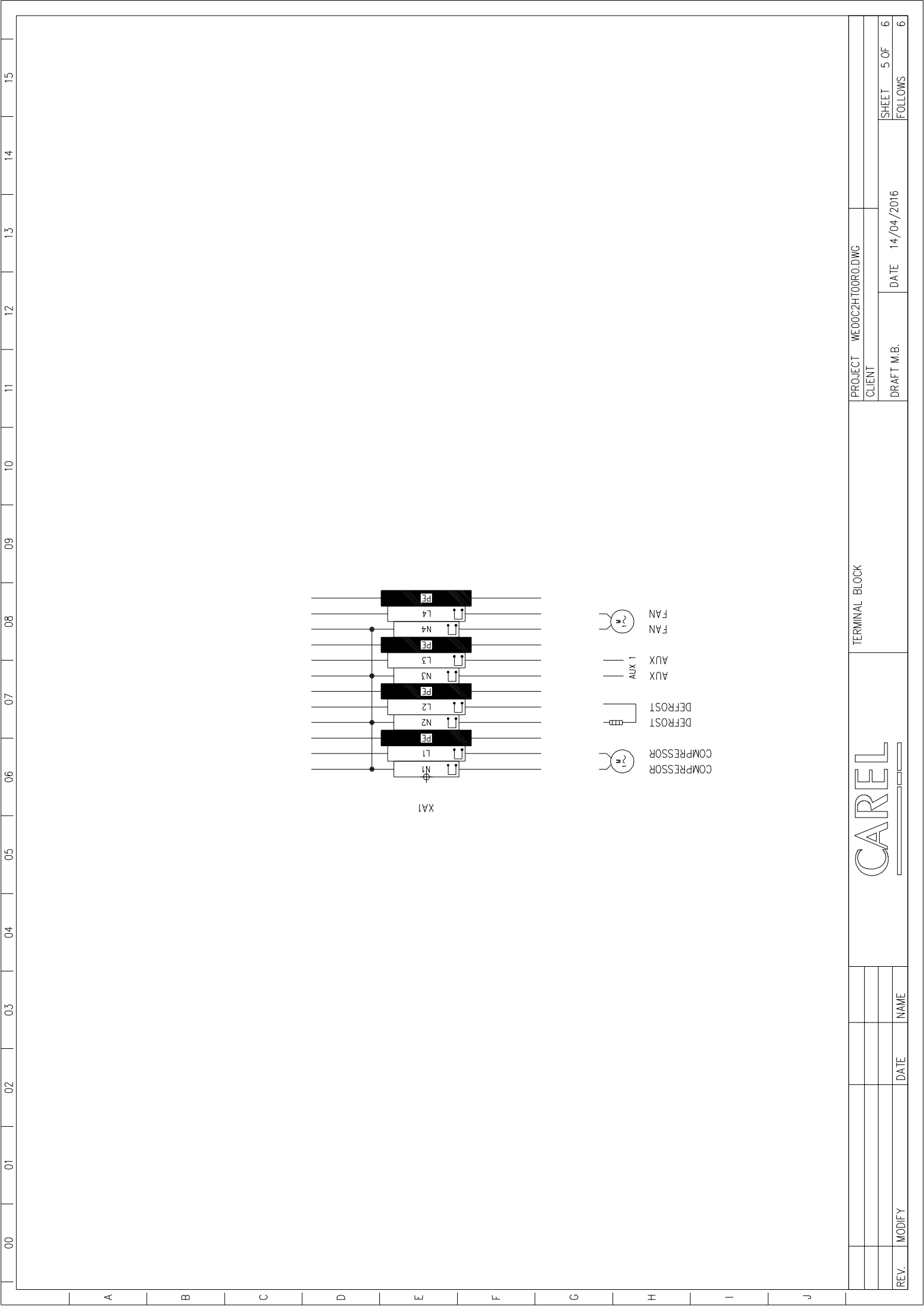

PROJECT	WE00C2HT00R0.DWG
CLIENT	
DRAFT M.B.	DATE 14/04/2016
SHEET 5 OF 6	FOLLOWS 6

TERMINAL BLOCK

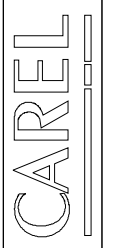

REV.	MODIFY	DATE	NAME

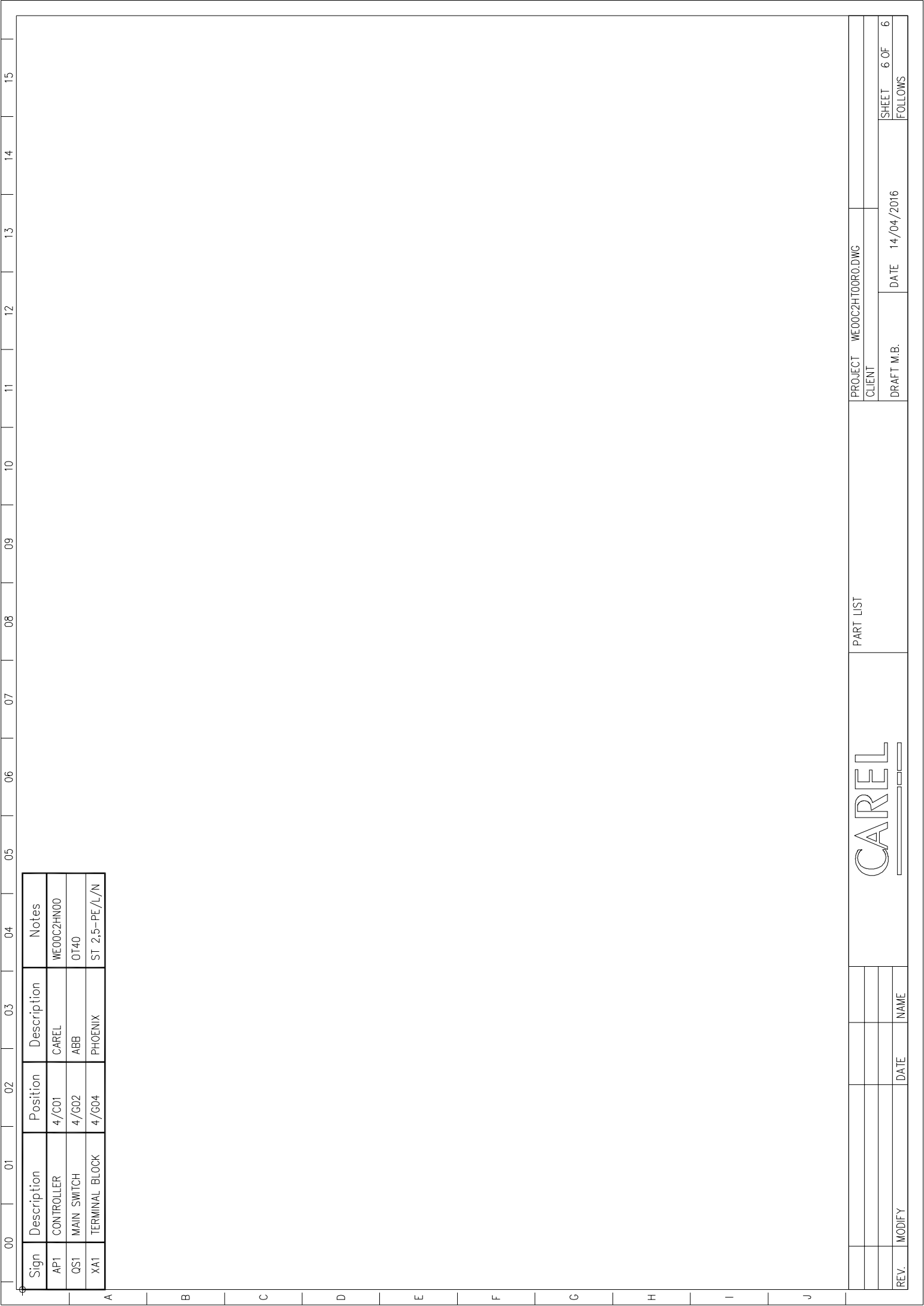

Sign	Description	Position	Description	Notes
AP1	CONTROLLER	4/C01	CAREL	WE00C2HN00
QS1	MAIN SWITCH	4/G02	ABB	0T40
XA1	TERMINAL BLOCK	4/G04	PHOENIX	ST 2.5-PE/L/N

PART LIST

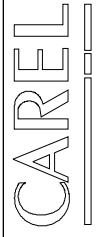

PROJECT	WE00C2HT00R0.DWG
CLIENT	
DRAFT M.B.	DATE 14/04/2016
	SHEET 6 OF 6
	FOLLOWS

REV.	MODIFY	DATE	NAME